

Hands-on Open vSwitch and Software-defined Networking

Jorge Crichigno, Shahrin Sharif, Elie Kfoury
University of South Carolina
<http://ce.sc.edu/cyberinfra>
jcrichigno@cec.sc.edu, ssharif@email.sc.edu

WASTC 2021 virtual Faculty Development Weeks (vFDW)
June 25, 2021

Virtual Local Area Network (VLAN)

VLAN Definition

- At the simplest level, a VLAN is a way to partition a single switch into multiple switches
- Through VLANs, a group of devices on one or more LANs can be configured to communicate as if they were attached to the same wire

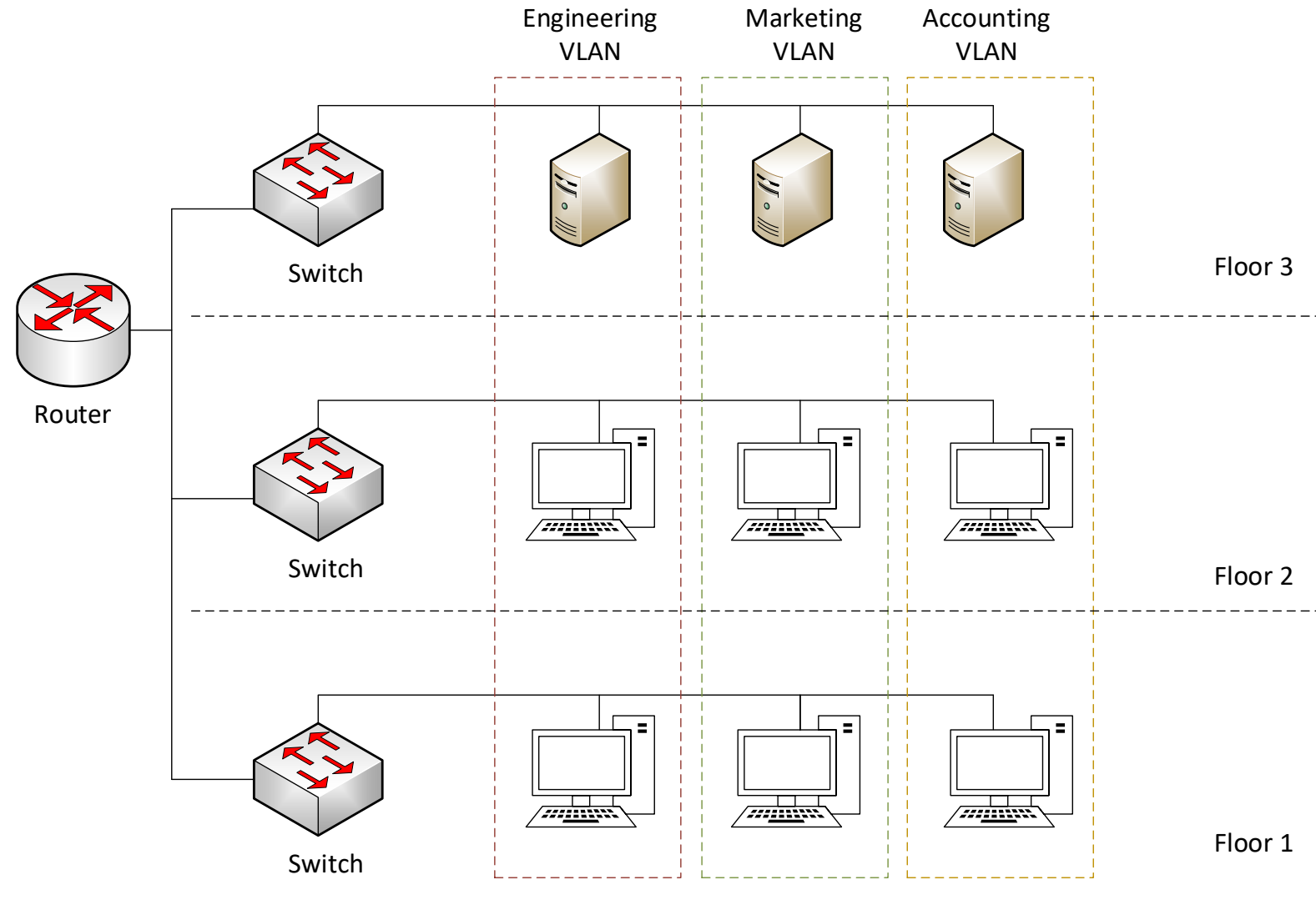

Cisco Systems, "Catalyst 4500 Series Switch Cisco IOS Software Configuration Guide," 2018

Lab topology

- Hosts h1 and h3 belong to VLAN 10, hosts h2 and h4 belong to VLAN 20
- s1-eth3 and s2-eth3 interfaces act as trunk ports

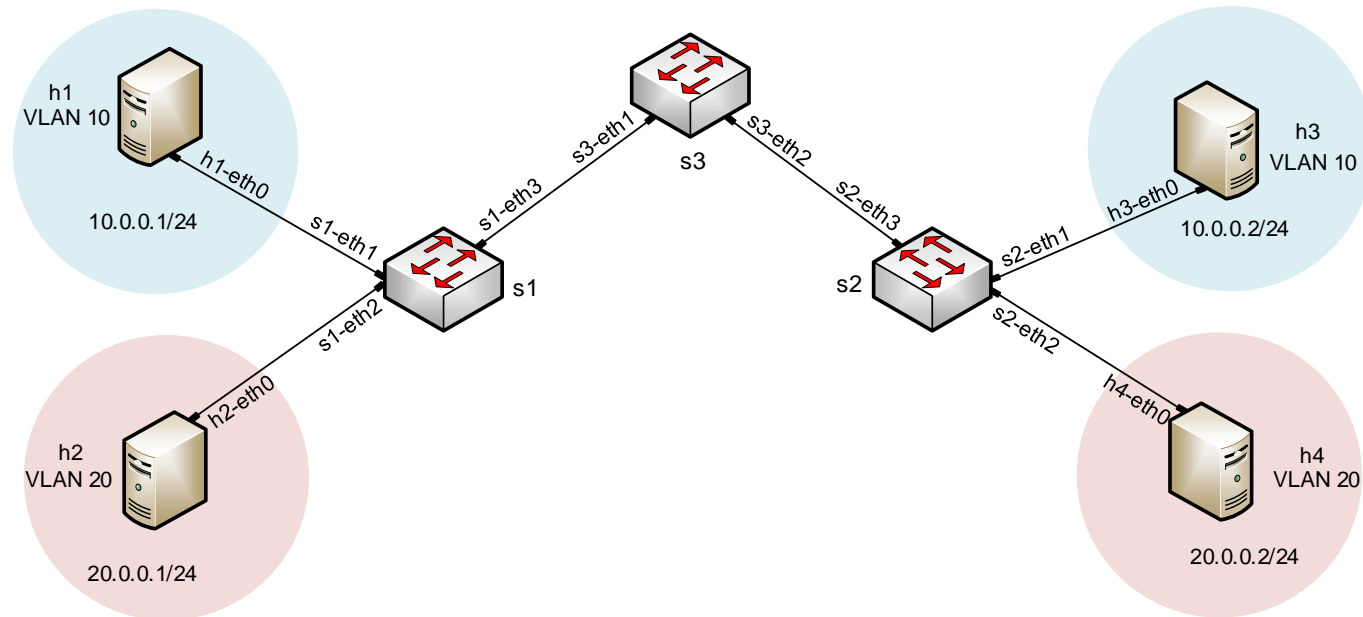

VLAN access ports

- An access port can have only one VLAN configured on the interface
- It can carry traffic for only one VLAN

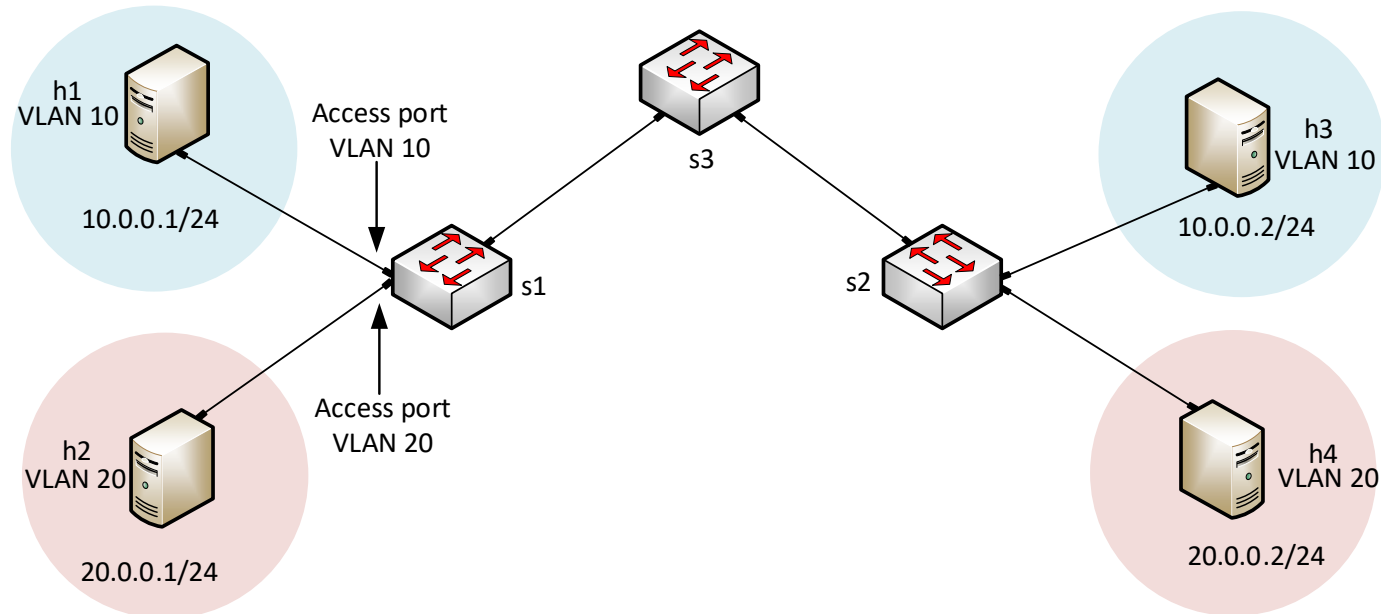

VLAN trunk ports

- A trunk port can have two or more VLAN configured on the interface
- It can carry traffic for several VLANs simultaneously

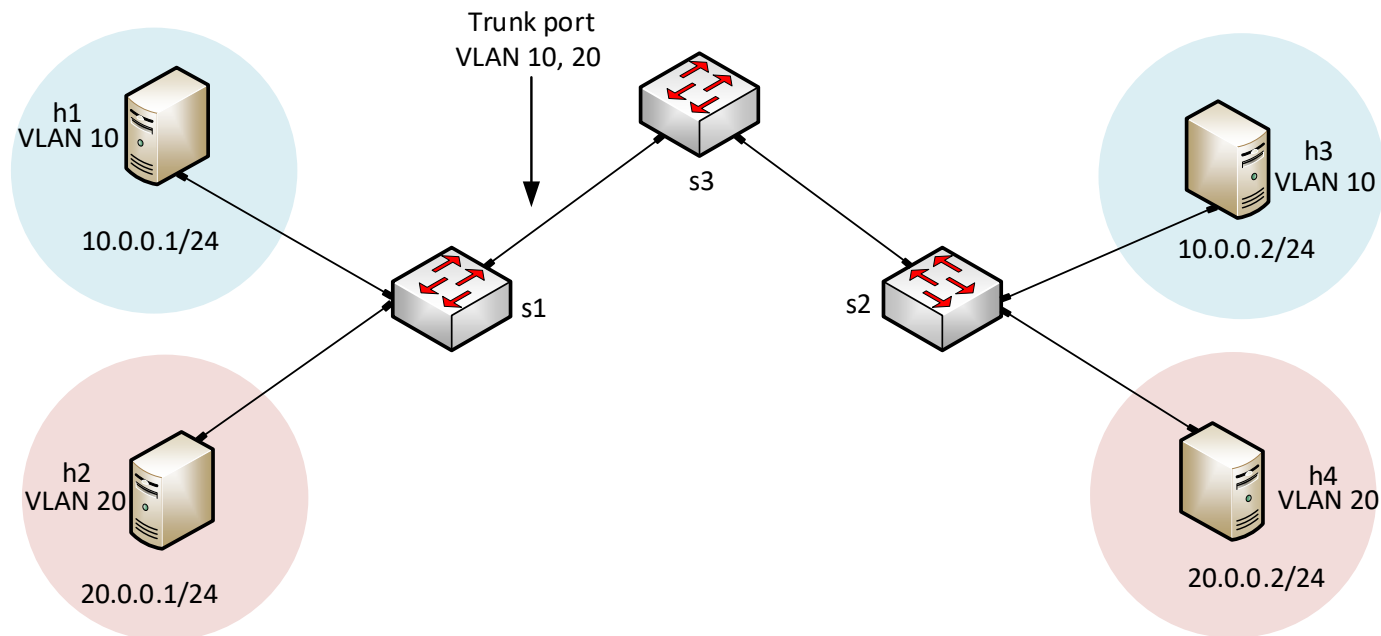

Additional Slides

VLAN-tagged Ethernet Frame

- 16 bit: VLAN Protocol ID
- 3 bit: Priority Code Point (PCP)
- 1 bit: Drop Eligible Indicator (DEI, or formerly CFI)
- 12 bit: VLAN ID

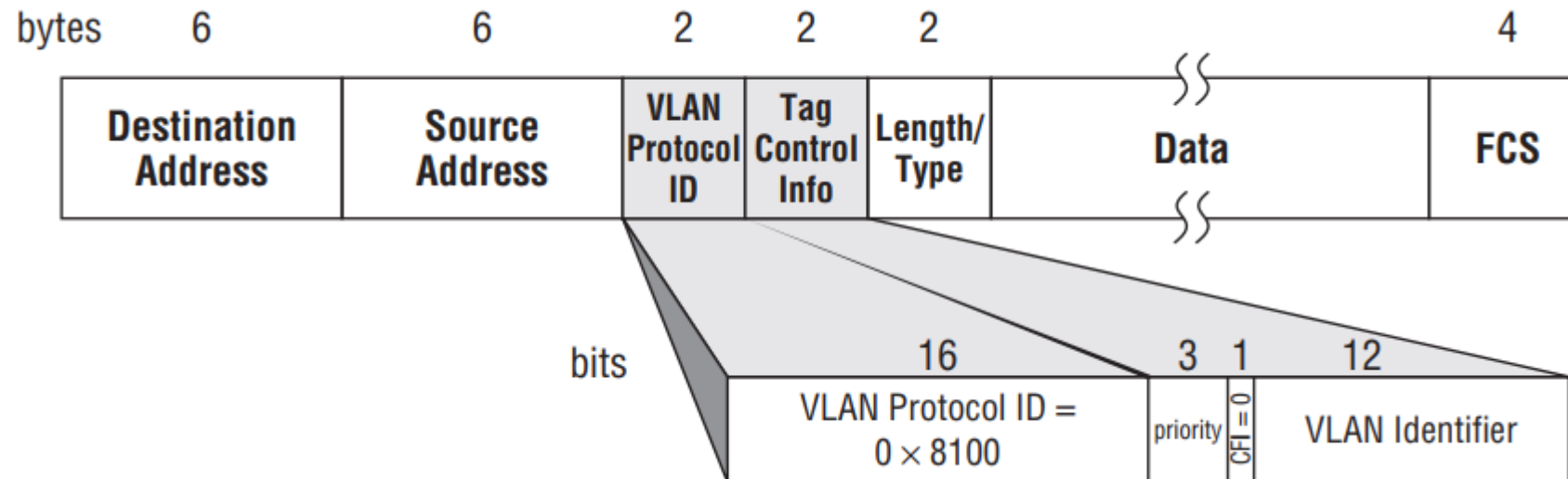

R Seigert, J. Edwards "The All-New Switch Book – The Complete Guide to LAN Switching Technology," Wiley Publishing, Inc., 2008

Applications of VLANs

- Increase in configuration flexibility
 - Configure any arbitrary set of users, servers, and other equipment as a closed group (i.e., a VLAN), even when they are in separate buildings or geographical areas

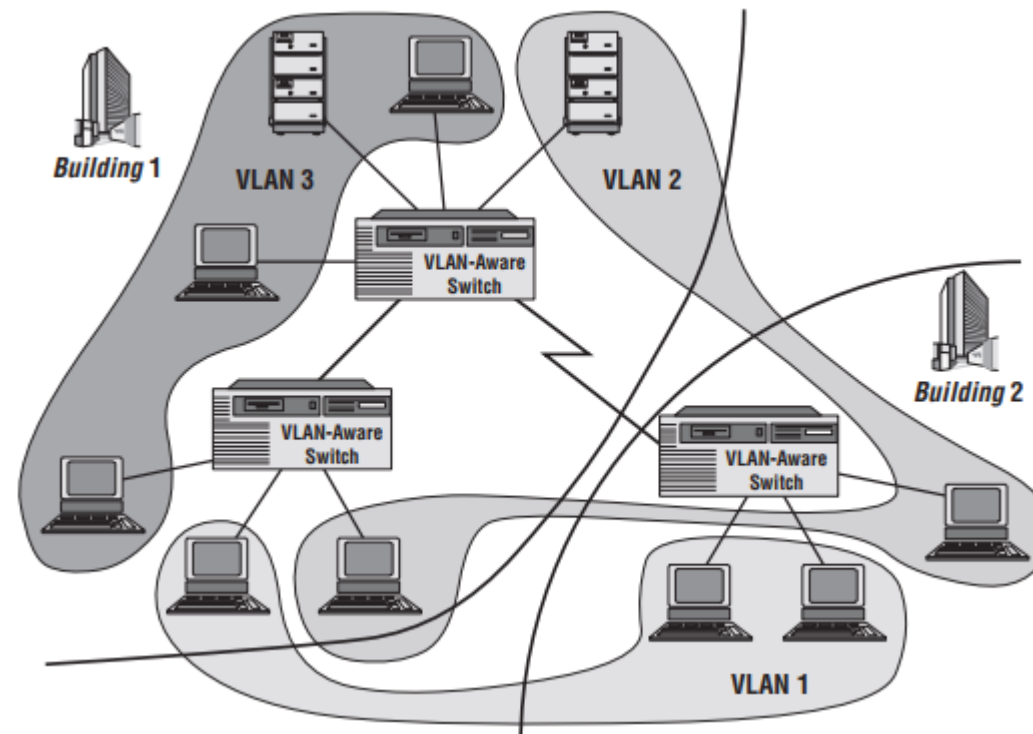

R Seigert, J. Edwards "The All-New Switch Book – The Complete Guide to LAN Switching Technology," Wiley Publishing, Inc., 2008

Applications of VLANs

- LAN security
 - VLAN does not forward traffic among switch ports associated with members of different VLANs. Thus, enhancing the protections against both unwanted eavesdropping and bogus transmissions

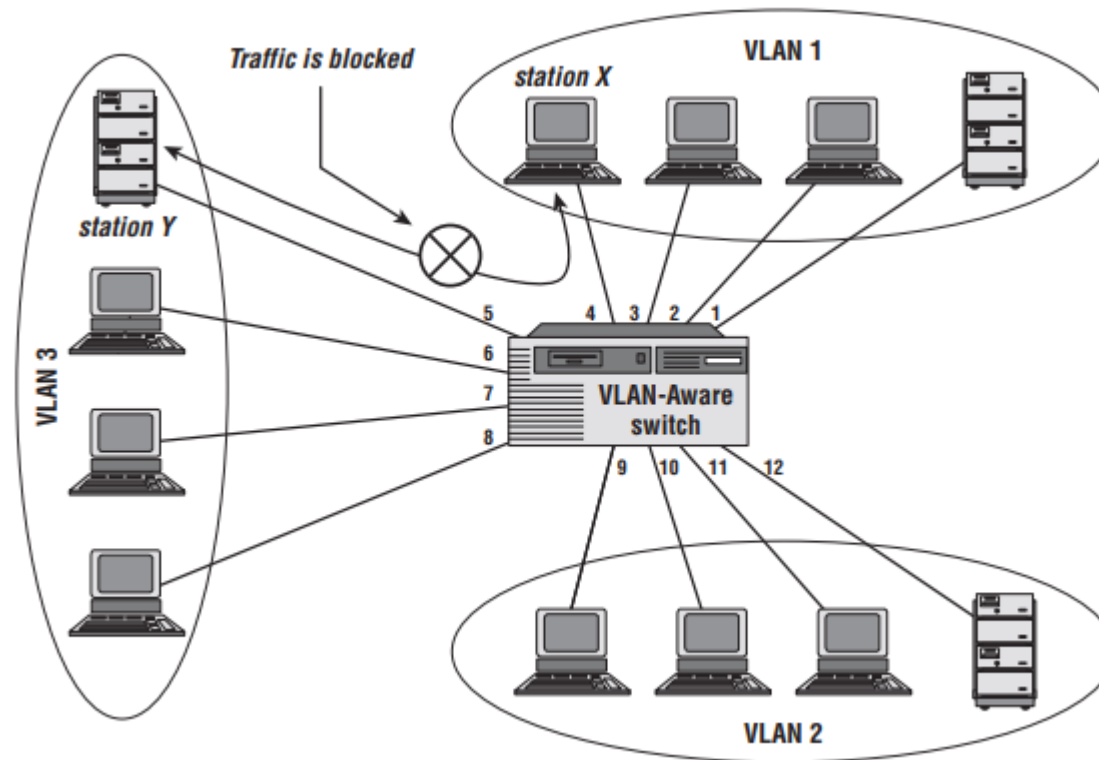

R Seigert, J. Edwards "The All-New Switch Book – The Complete Guide to LAN Switching Technology," Wiley Publishing, Inc., 2008

Applications of VLANs

- User mobility
 - The user's view of the network can remain consistent regardless of the geographical location, i.e., users do not have to explicitly deal with their own mobility
 - Network layer addresses may not need to be changed with based on the location in the organization

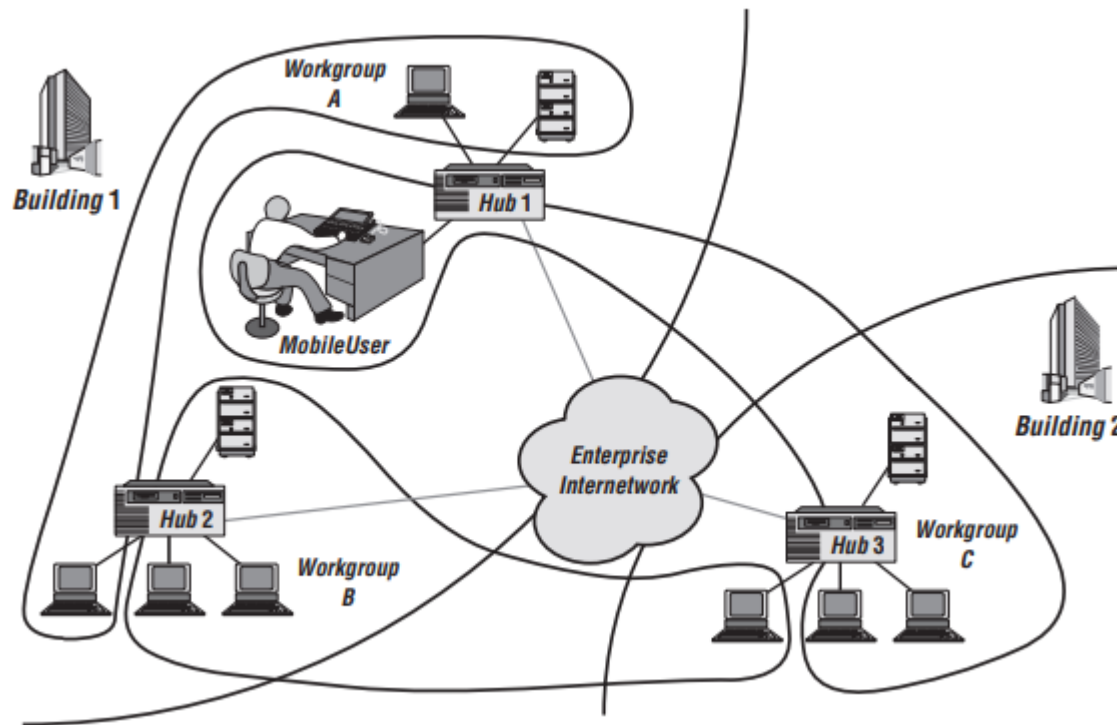

R Seigert, J. Edwards "The All-New Switch Book – The Complete Guide to LAN Switching Technology," Wiley Publishing, Inc., 2008