

# UofSC – Trident Tech Meeting Information Technology Programs

Department of Integrated Information Technology (IIT)  
College of Engineering and Computing  
University of South Carolina

Online  
August 6, 2020

# Agenda

- Cybersecurity
- Cybertraining
- ATE with NDG

# Cybersecurity Project

- Cybersecurity project started in 2018
- Local private cloud for teaching and research in cyber at UofSC
- Build custom pods
- Real protocol stacks and live traffic experimentation
- Network emulation with NETEM and Mininet

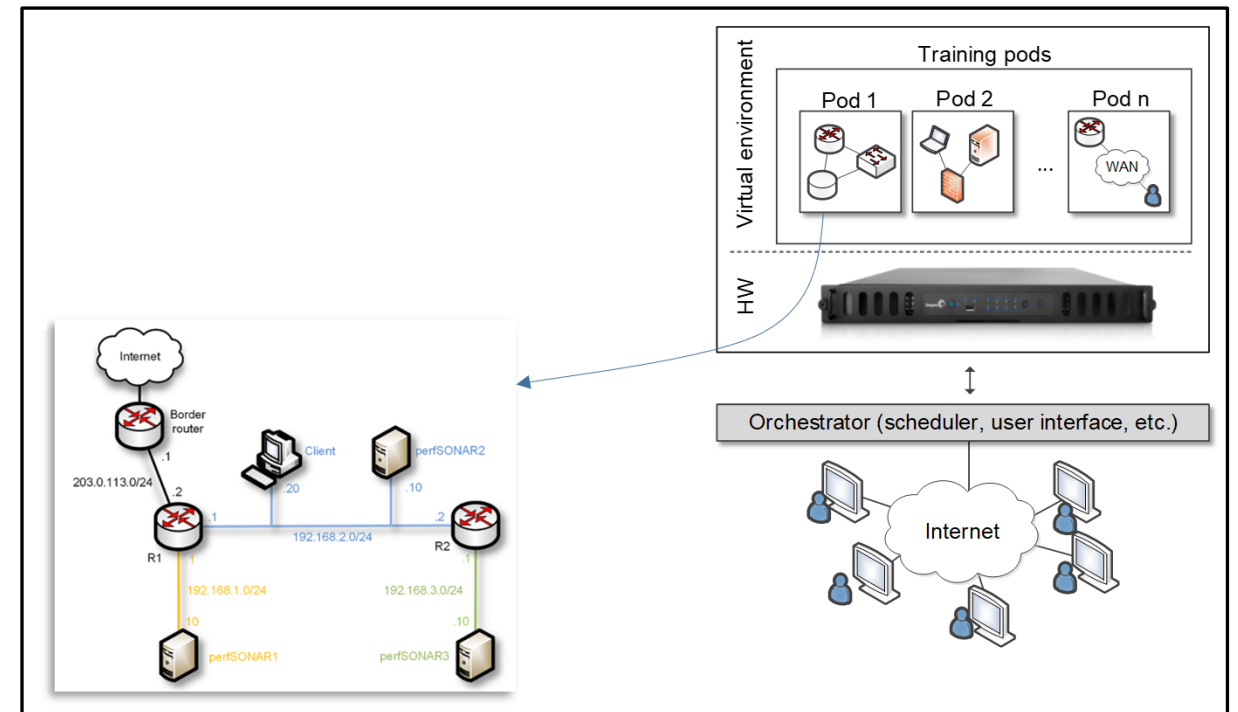

# Cybertraining Project

- Cybertraining project started in 2019: Cyberinfrastructure for moving big data
- There is a need for IT technical expertise country-wide
- E.g., ESnet is the network connecting national labs, research institutions
  - Managed by the Department of Energy (Berkeley National Lab)
- Rates of 50 Gbps, emulation of high-performance systems



ESnet

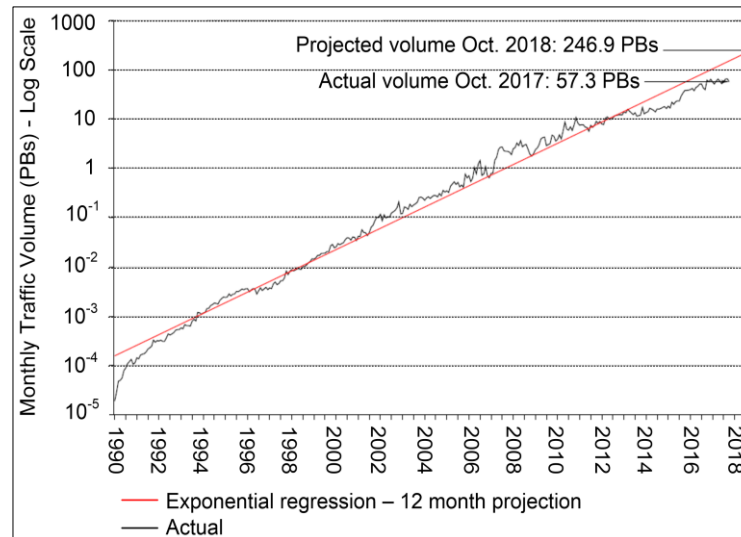

Monthly average traffic volume, ESnet

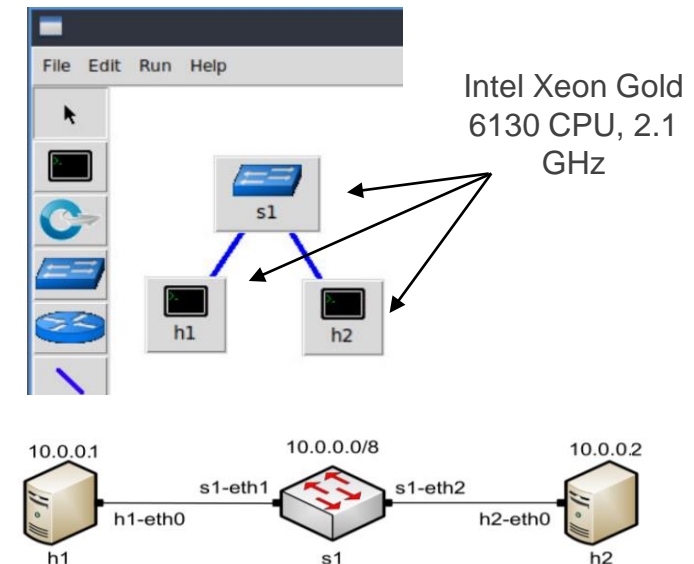

Three-node network emulation

# ATE and CC Projects

- Advanced Technical Education (ATE) and Campus Cyberinfrastructure (CC) (2019)
- Development of a multi-state distributed cloud to support teaching, research
- 2+2+2 program (HS + College + University)
- Distributed cloud pools resources from SC and NC, serves institutions seamlessly
- Requests to use the platform, NDG + UofSC
  - Berkeley National Lab
  - SANS institute (“girlsgocyber”)
  - Multiple higher-ed institutions
  - International Networks at Indiana
  - Fort Gordon (2 cyber courses)
  - Texas’ Lonestart Education and Research

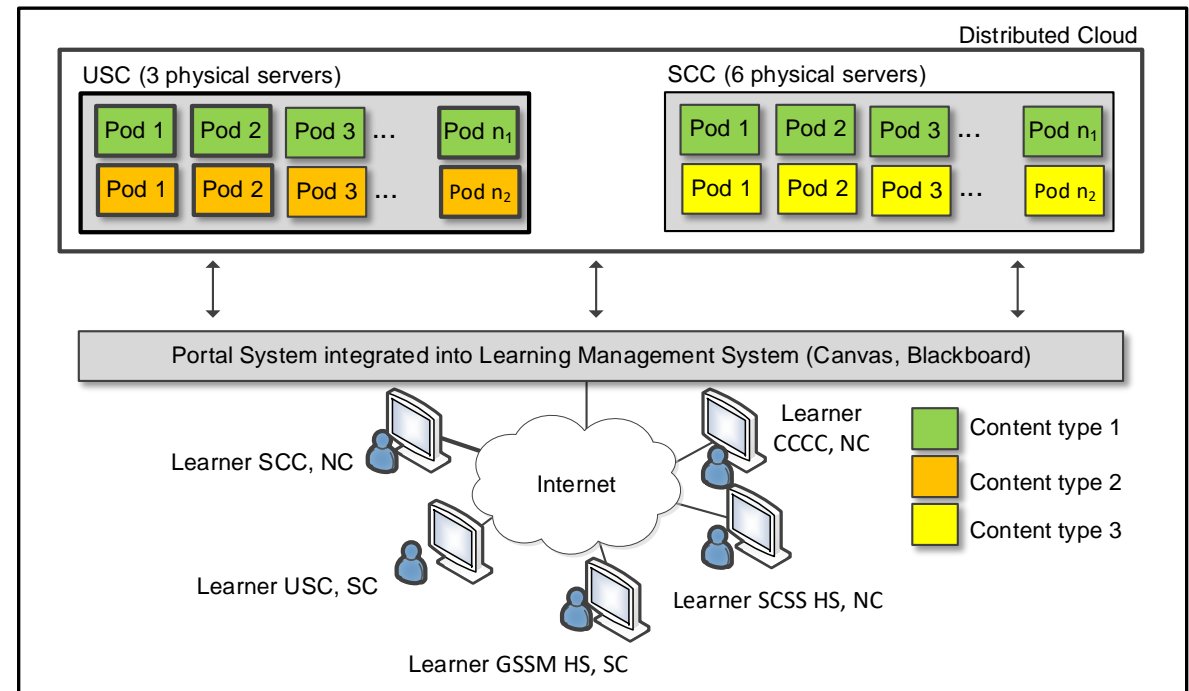

# Status: Platform + Expertise on vLabs

- UofSC vLabs series
  - Network Tools and Protocols (high-speed networks)
  - Software Defined Networking
  - Zeek Intrusion Detection
  - perfSONAR
  - Intro to BGP
  - MPLS and Advanced BGP Topics
- NDG vLabs series
  - Cisco, Palo Alto, Red Hat
  - Cybersecurity
  - Linux
  - Custom series

IT professionals,  
4-year, grad. degrees

Technical colleges, 4-  
year universities, certs,  
ROTC

High schools, dual  
credit, certs

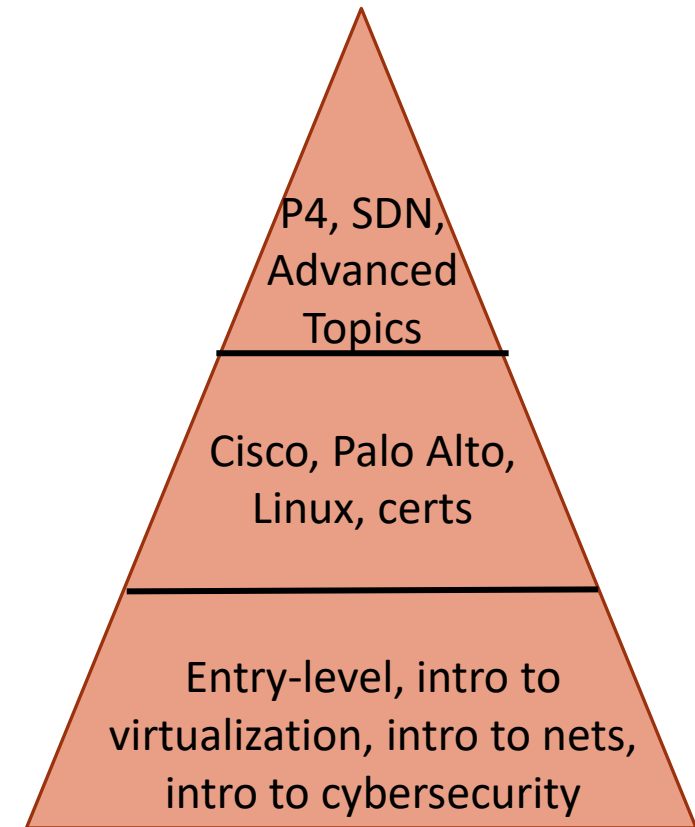

# Private Cloud Use

- Private vs public cloud

Feature	Private Cloud	Public Cloud (e.g., AWS)
<b>Granularity to allocate physical resources</b>	Very granular	Not granular (access to the physical resources requires additional fees)
<b>Easy to create custom pods</b>	Easy	More difficult; hard to design complex topologies
<b>Cost</b>	Cost effective when used extensively	Cost effective for individual / small virtual machines; costly for large virtual machines over time
<b>IT Staff</b>	Higher cost	Lower cost
<b>Application layer for pedagogy and presentation of virtual scenarios</b>	Very flexible	Not flexible; limited to providers' interface, e.g., command-line interface
<b>Time-sharing compute resources</b>	The owner controls who can access resources. Easy to implement time-sharing policies	Cloud provider controls who can access resources (typically, a fee is required per user accessing resources)

# ONR's Cyber Project

- “Enhancing the Preparation of Next-generation Cyber Professionals” (2020)
- South Carolina cybersecurity needs
  - NIWC Atlantic, SRNL, Fort Jackson, Shaw Air Force Base, private industry
- Recruiting the American military's cyber force is more difficult than ever
  - DoD has been struggling to hire more than 8,000 cyber positions (2018)<sup>1</sup>
  - Shortage of cybersecurity professionals
- The College of Engineering and Computing is addressing the workforce needs:
  - Encourage STEM, **ROTC** students to obtain a minor in IT
  - Undergraduate applied research
  - Private cloud
  - Collaboration among industry, government, education institutions

Cybersecurity job openings in four metro areas near Columbia, Feb. 2020

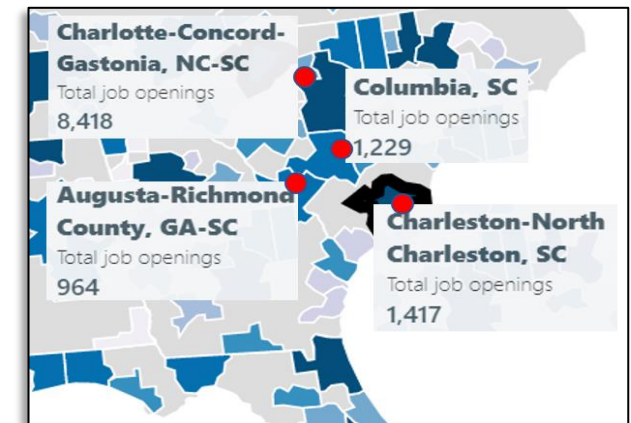

1. J. Lynch, “Inside the Pentagon’s Struggle to Build a Cyber Force,” Fifth Domain publication, October 29, 2018. Online: <https://tinyurl.com/yyelqomp>



# ONR's Cyber Project

## 1. Minor in IT – Cyber specialization

- Option to earn DoD's approved baseline certificates for Information Assurance Technical (IAT)
- Self-contained specialization; no pre-req for other STEM majors / **ROTC**

## 2. Undergraduate applied research

- CEC faculty, graduate student mentors
- Advisory entity by NIWC Atlantic, project guidelines

## 3. Private cloud with professional tools and platforms

- Hands-on applied research with physical and virtual equipment

## 4. Collaboration

- Partnership with Intel, Cisco Systems, Palo Alto Networks, VMware, Juniper

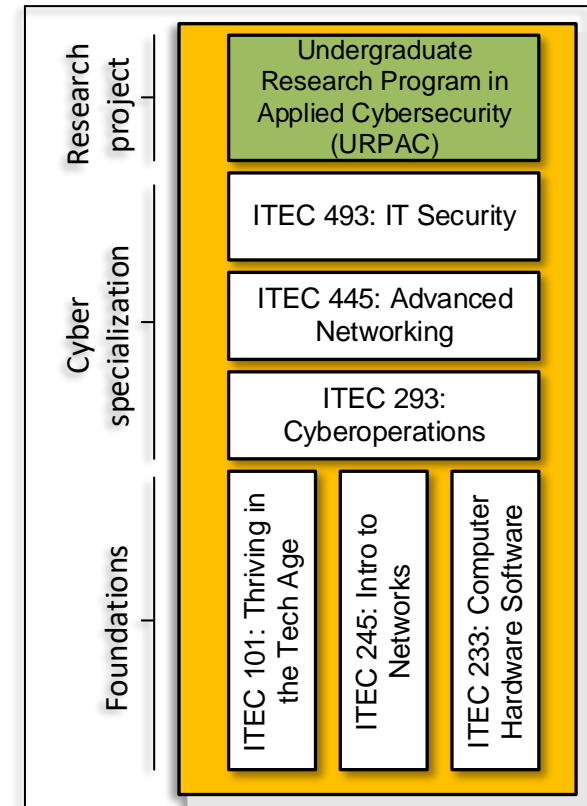

Minor in IT and undergraduate research

# ONR's Cyber Project

- DoD's Information Assurance (IA) workforce is classified in IA technical (IAT):
  - Level 1 (IAT 1): Computing environment information assurance
  - Level 2 (IAT 2): Network environment information assurance
  - Level 3 (IAT 3): Enclave, advanced network & computer information assurance
- It requires partnership
  - Cisco Systems, Palo Alto Networks, VMware, Juniper, Intel

Certificate	Material Covered in	IAT 1	IAT 2	NICE framework	Networks cert.
A+	ITEC 233	✓		✓	
Cyberoperations	ITEC 293	✓		✓	
Security+	ITEC 293	✓	✓	✓	
CCNA Security	ITEC 493	✓	✓	✓	
CCNA Routing/Switching	ITEC 245, ITEC 445				✓
ACE	ITEC 493			✓	
PCNSE	ITEC 493			✓	

NICE: National Initiative for Cybersecurity Education (NIST)

# ONR's Cyber Project

- Collaboration

- Applied teaching and research -> professional tools, platforms, market validation
- Cisco Systems, Palo Alto Networks, VMware, Juniper, Intel

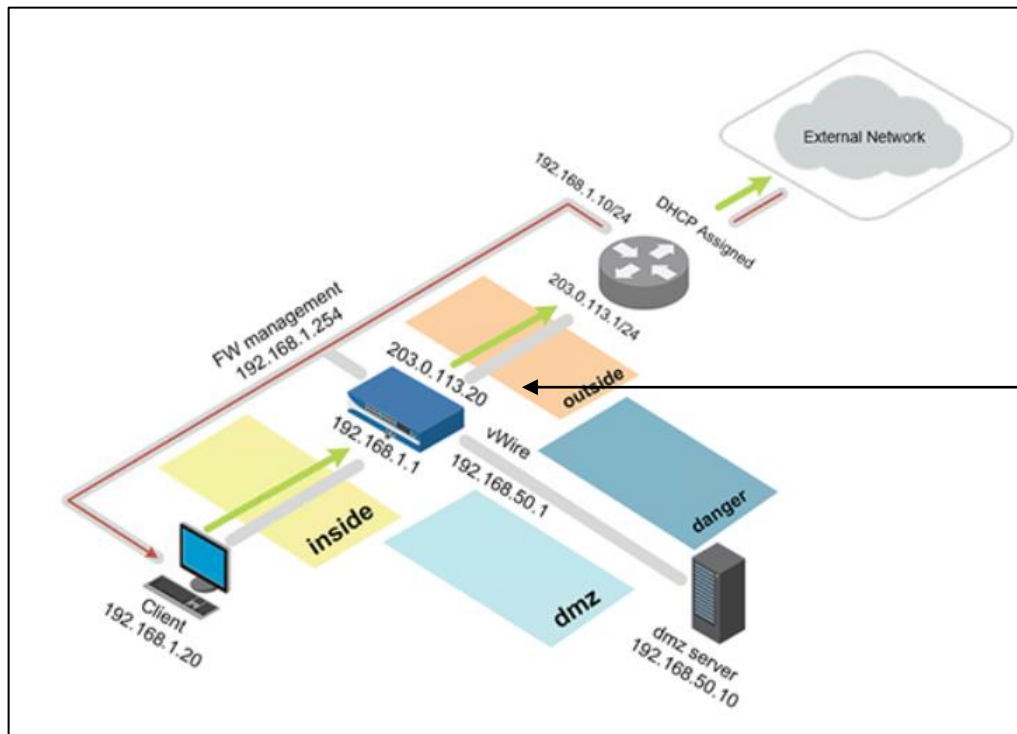

Next-generation Firewall Virtual Machine + licenses

Pod deployed in private cloud

# ONR's Cyber Project

- Collaboration

- Applied teaching and research -> professional tools, platforms, market validation
- Cisco Systems, Palo Alto Networks, VMware, Juniper, Intel

- ✓ Bachelor's degree
- ✓ IAT
- ✓ Theory
- ✓ Hands-on expertise Palo Alto

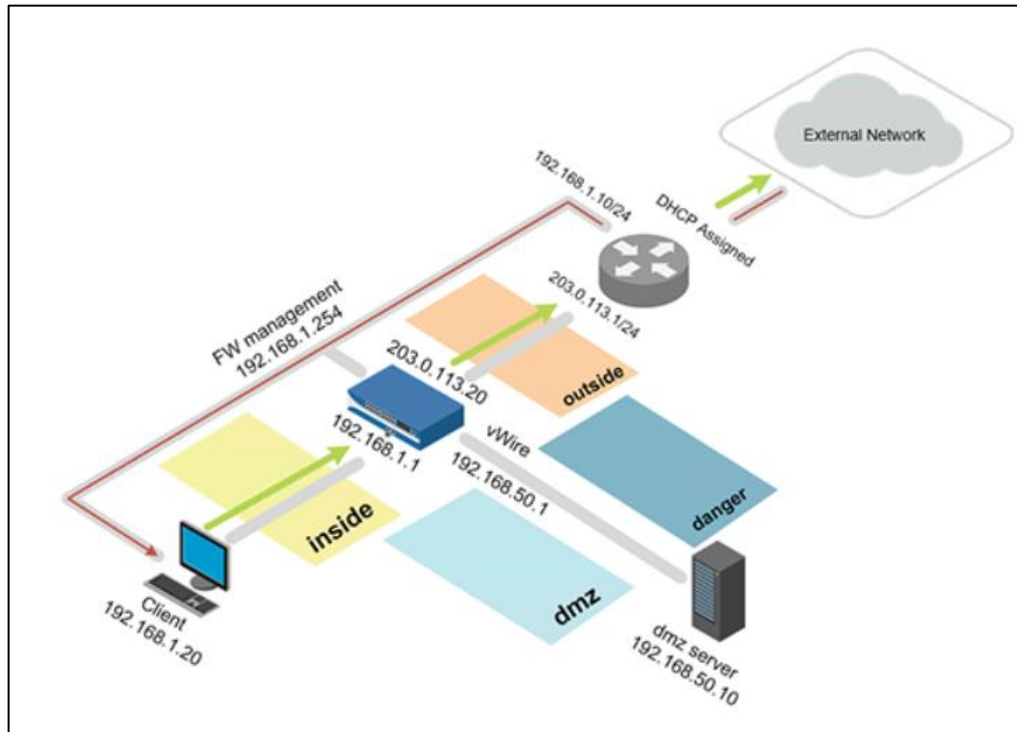

Pod deployed in private cloud

The screenshot shows a job search on CareerBuilder. The search criteria are 'Firewall in US', resulting in '1,214 Jobs Found'. The top job listing is 'Cybersecurity Systems Engineer - Palo Alto Firewall' at Base-2 Solutions, LLC in Washington, DC. The job details include a required security clearance of 'Top Secret/SCI' and a specific requirement: '8570 Category Requirement: IAT Level II'. Other job listings shown include 'IT Project Manager' at ComTec and 'Senior Network Engineer' at Blackstone Technology Group, Inc.

Job search

# ONR's Cyber Project

- Collaboration

- Applied teaching and research -> professional tools, platforms, market validation
- Cisco Systems, Palo Alto Networks, VMware, Juniper, Intel

- ✓ Bachelor's degree
- ✓ IAT
- ✓ Theory
- ✓ Hands-on expertise Palo Alto

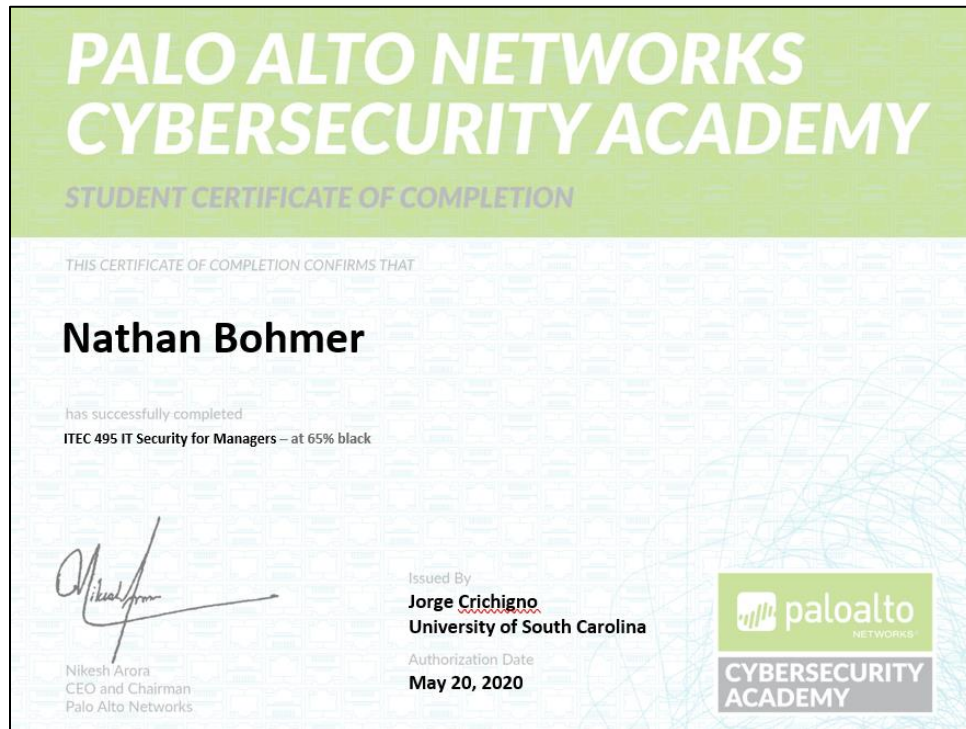

Additional credentials

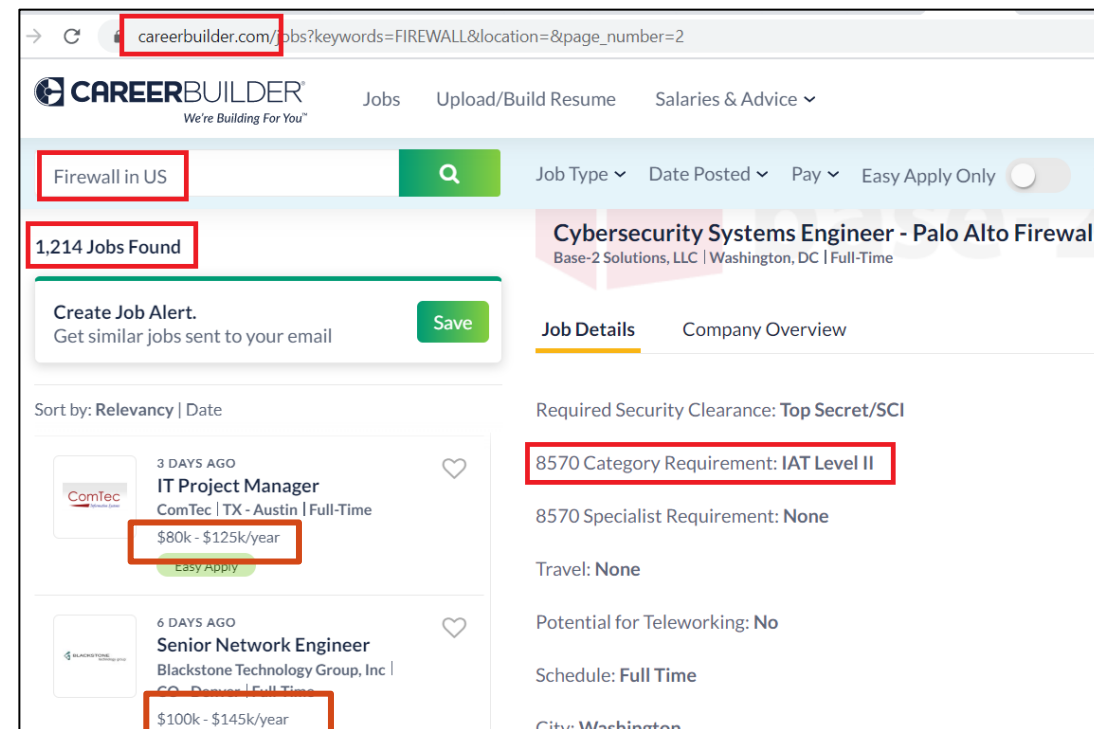

Job search

# ONR's Cyber Project

- Collaboration

- Applied teaching and research -> professional tools, platforms, market validation
- Cisco Systems, Palo Alto Networks, VMware, Juniper, Intel

- ✓ Bachelor's degree
- ✓ IAT
- ✓ Theory
- ✓ Hands-on expertise Palo Alto

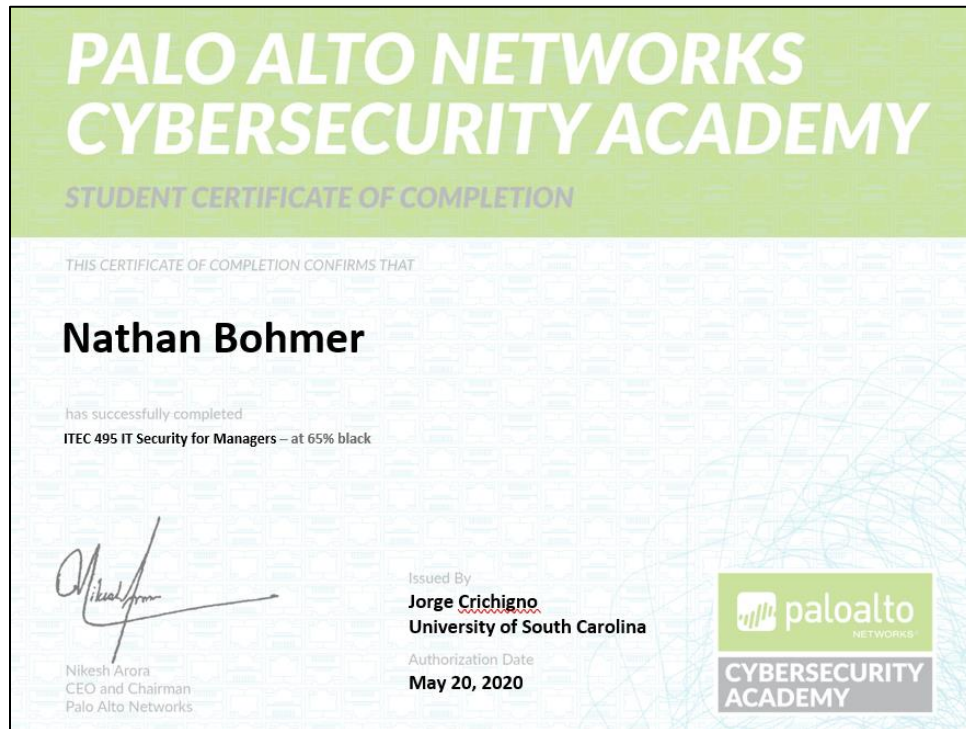

Additional credentials



UofSC's ROTC

# Graduate Projects

- Development of new techniques against attacks targeting “Internet-of-Things” devices
- Agreement with the Center for Applied Internet Data Analysis (CAIDA) (San Diego)

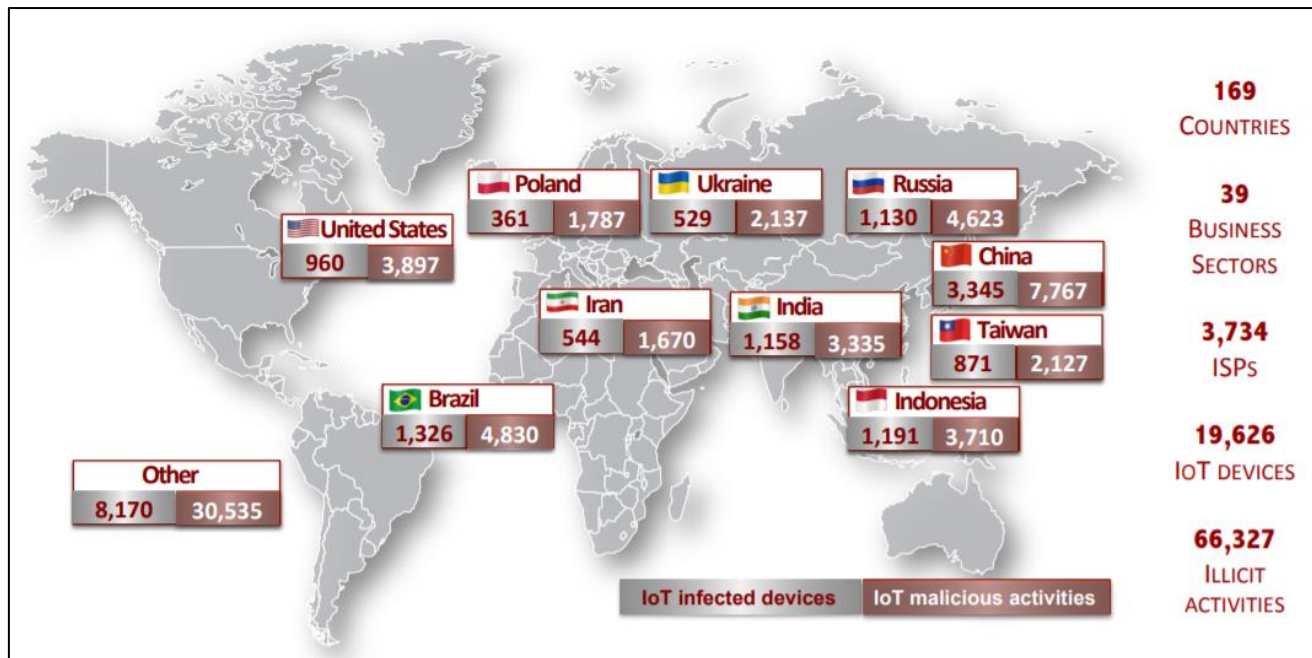

Global distribution of exploited IoT devices; results from this research project

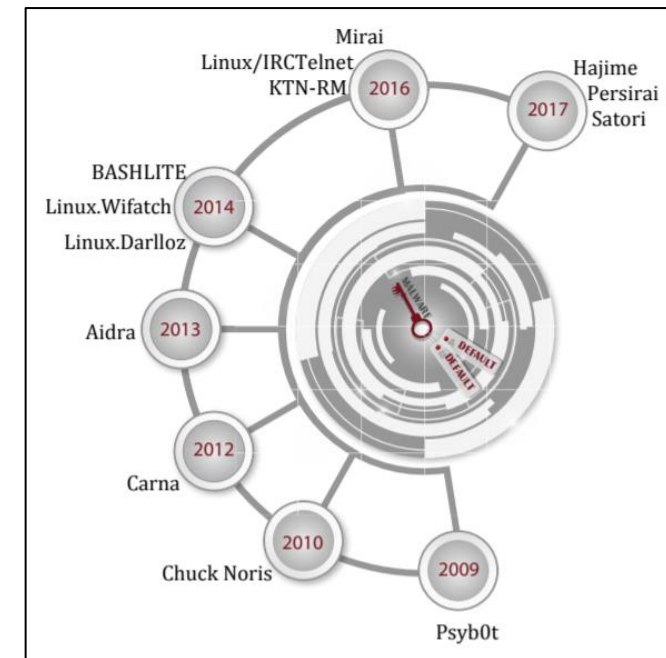

Malware exploiting default credentials

# Graduate Projects

- Development of new techniques against attacks targeting “Internet-of-Things” devices
- Agreement with the Center for Applied Internet Data Analysis (CAIDA) (San Diego)

## Demystifying IoT Security: An Exhaustive Survey on IoT Vulnerabilities and a First Empirical Look on Internet-scale IoT Exploitations

Nataliia Neshenko, Elias Bou-Harb, Jorge Crichigno, Georges Kaddoum and Nasir Ghani

*Abstract*—The security issue impacting the Internet-of-Things (IoT) paradigm has recently attracted significant attention from the research community. To this end, several surveys were put forward addressing various IoT-centric topics including intrusion detection systems, threat modeling and emerging technologies. In contrast, in this work, we exclusively focus on the ever-evolving IoT vulnerabilities. In this context, we initially provide a comprehensive classification of state-of-the-art surveys, which address various dimensions of the IoT paradigm. This aims at facilitating IoT research endeavors by amalgamating, comparing and contrasting dispersed research contributions. Subsequently, we provide a unique taxonomy, which sheds

physical therapy [4], while the Autism Glass [5] aims at aiding autistic children to recognize emotions of other people in real-time [6].

Safety-centric IoT solutions endeavor to minimize hazardous scenarios and situations. For example, the concept of connected vehicles prevents the driver from deviating from proper trajectory paths or bumping into objects. Further, such concept enables the automatic emergency notification of nearest road and medical assistance in case of accidents [7]. Additionally, autonomous, self-driving mining equipment



# Graduate Projects

- Performance testing Google's new communication protocol
- Feedback to Google (used in Youtube, Chrome, and other apps)
- Emulating behavior in private cloud before Google's protocol public release

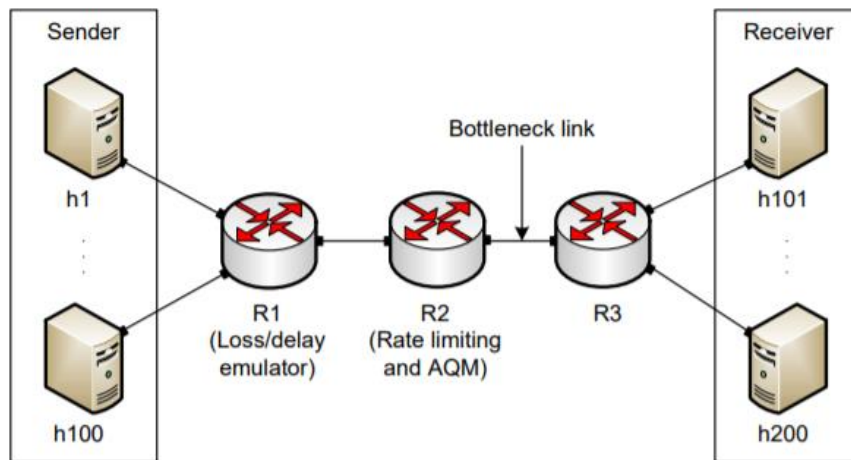

Computer Communications

Available online 25 July 2020

In Press, Journal Pre-proof



## An emulation-based evaluation of TCP BBRv2 Alpha for wired broadband

Elie F. Kfoury <sup>a</sup>, Jose Gomez <sup>a</sup>, Jorge Crichigno <sup>a</sup>, Elias Bou-Harb <sup>b</sup>

[Show more](#)

<https://doi.org/10.1016/j.comcom.2020.07.018>

[Get rights and content](#)

### Abstract

Google published the first release of the Bottleneck Bandwidth and Round-trip Time (BBR) congestion control algorithm in 2016. Since then, BBR has gained a

# Graduate Projects

- Improving system's performance using next-generation switches
- Offloading computational tasks to network switches
  - Orders of magnitude faster than general-purpose CPU
  - Very limited instructions set (e.g., no multiplication, no division, simple operations)
- Agreement with Intel (chips, software development environment)

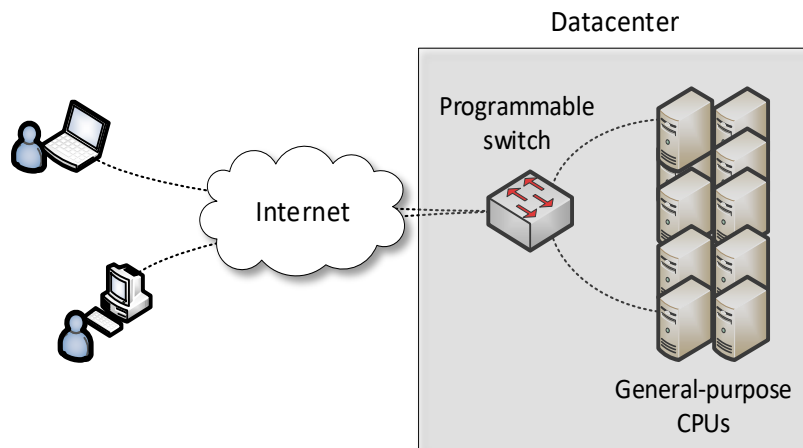

Application example: media (voice) relay server

	<b>Programmable Switch</b>	<b>General-purpose CPU</b>
<b>Cost</b>	\$6,000	\$ 10,000 - 25,000
<b>Capacity</b>	~35,000,000 connections per switch	~500 connections per core
<b>Latency</b>	400 nanoseconds	Tens to hundreds of milliseconds

# Graduate Projects

- Improving system's performance using next-generation switches
- Offloading computational tasks to network switches
  - Orders of magnitude faster than general-purpose CPU
  - Very limited instructions set (e.g., no multiplication, no division, simple operations)
- Agreement with Intel (chips, software development environment)

## Offloading Media Traffic to Programmable Data Plane Switches

Elie F. Kfoury\*, Jorge Crichigno\*, Elias Bou-Harb†, Vladimir Gurevich‡

\*Integrated Information Technology, University of South Carolina, USA

†The Cyber Center For Security and Analytics, University of Texas at San Antonio, USA

‡Barefoot Networks, an Intel Company, USA

**Abstract**—According to estimations, approximately 80% of Internet traffic represents media traffic. Much of it is generated by end users communicating with each other (e.g., voice, video sessions). A key element that permits the communication of users that may be behind Network Address Translation (NAT) is the relay server.

This paper presents a scheme for offloading media traffic from relay servers to programmable switches. The proposed scheme relies on the capability of a P4 switch with a customized parser to de-encapsulate and process packets carrying media traffic. The switch then applies multiple switch actions over the packets. As these actions are simple and collectively emulate a relay server, the scheme is capable of moving relay functionality to the data plane operating at terabits per second. Performance

results [8] reveal that CGN has a widespread adoption and that over half of operators have deployed or will deploy CGN. NAT introduces issues such as violation of the end-to-end principle, scalability and reliability concerns, and traversal of end-to-end sessions. The latter is a problem that severely affects media traffic. For example, for an end user to be reachable for an end-to-end media session (voice, video), the user must wait and accept incoming connections at a well-known port. With NAT, the user is not reachable because it is assigned a private IP address. Furthermore, port numbers are also allocated dynamically. Moreover, these dynamic allocations

(ASICs). This model is referred to as "disaggregated" as the software and hardware are decoupled; essentially, vendors' switching silicon (e.g., Broadcom) are compatible with different

## Enabling SONiC Functionalities in Disaggregated Network Switches

Ali AlSabeH\*, Elie Kfoury\*, Jorge Crichigno\*, Elias Bou-Harb†

Information Technology Dept., University of South Carolina (USC), Columbia, South Carolina, USA

The Cyber Center For Security and Analytics, Information Systems and Cyber Security Dept.

University of Texas at San Antonio (UTSA), San Antonio, Texas, USA

h@email.sc.edu, \*ekfoury@email.sc.edu, \*jcrichigno@cec.sc.edu, †elias.bouharb@utsa.edu

inception of the networking industry, devices have been limited to tightly-coupled components. Vendors provide closed source software, restraining network operators from customizing their devices, and hence hindering innovation. This is a costly, time consuming, and unscalable process that requires vendor's intervention. As a result, network operators are forced to use a limited set of manufacturing white-box switches that support Network Operating Systems (NOSs) that support application Specific Integrated Circuits

Network Operating Systems (NOSs), which are conceptualized, designed, developed, and sold by a specific company. The vendor provides the locked-in hardware with a pre-installed NOS, preventing the user from tampering it or installing third-party software. This behavior is beneficial among traditional networks where vendors have extensively tested their software before distributing it among clients. However, when it comes to adopting new technologies and scaling the network, vendors become cautious and reluctant due to security concerns, financial costs, and downtime drawbacks that might follow [2].

Bare metal (white-box) switches provide network engineers the

# NIWC Atlantic

---

- Collaboration with NIWC Atlantic is essential
  - We want to acknowledge Michael Merriken and Captain Sanders
- Advisory entity to the project
- Provide input for undergraduate research projects
- Coordination with UofSC's ROTC
  - Navy
  - Army
  - Air Force